

Name: _____

Date: _____

Color Long
Vowels red.

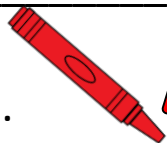

AEIOU

Color Silent
E gray



E

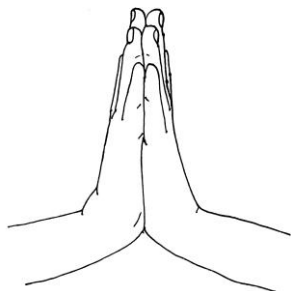

HOPE

hope

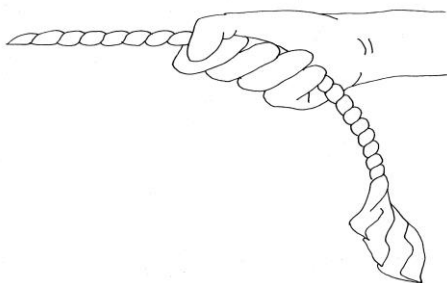

ROPE

rope

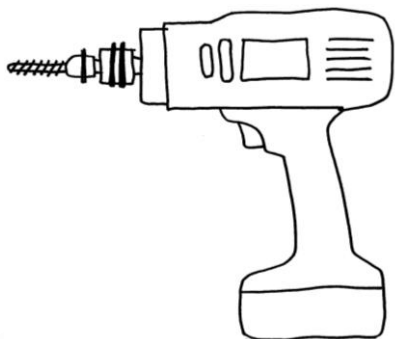

BORE

bore



CORE

core

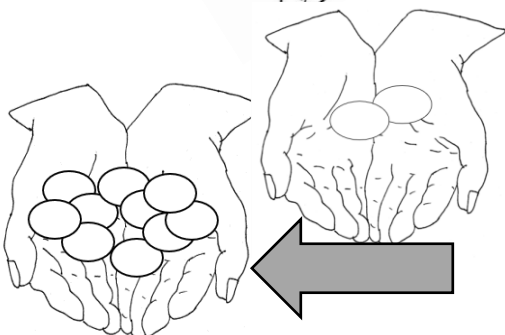

MORE

more

Long I, Magic E 3

Name: _____

Date: _____

Color Long Vowels red.



A E I O U

Color Silent E gray



E

Color CH pink.



Color Hard S purple.



SNORE

snore

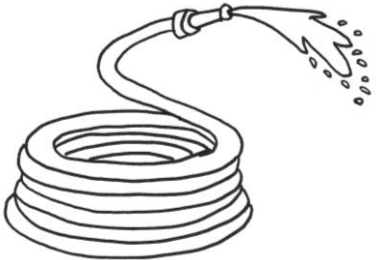

HOSE

hose

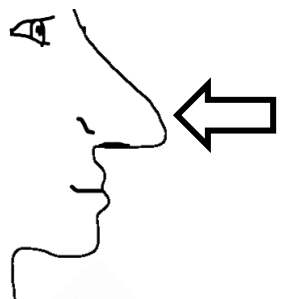

NOSE

nose

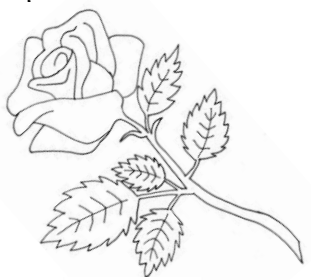

ROSE

rose

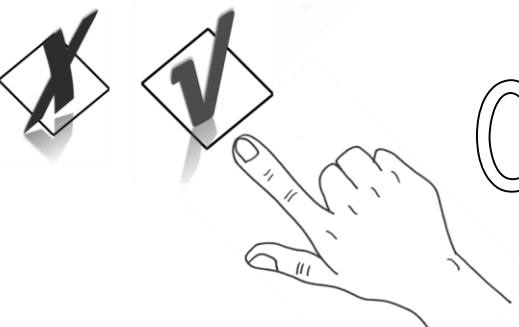

CHOSE

chose

Long O, Magic E 2

Name: _____

Date: _____

Color Long Vowels red.

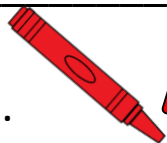

A E I O U

Color Silent E gray

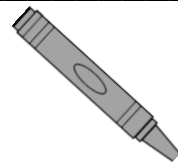

E

Color Hard S purple.

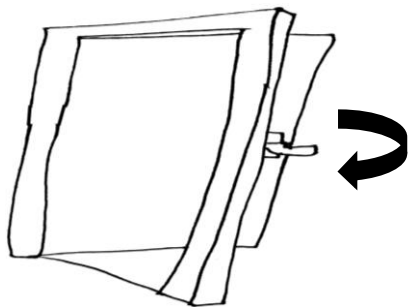

CLOSE **S**

close

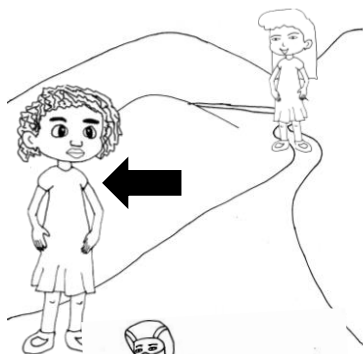

CLOSE

close

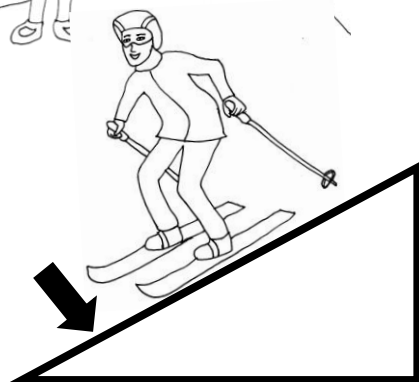

SLOPE

slope



ROBE

robe

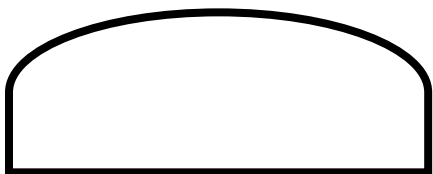

DOME

dome

Name: _____

Date: _____

Write the word: one letter in each box.

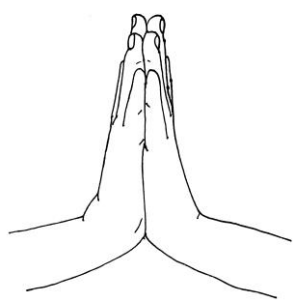
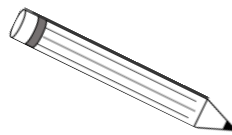

--	--	--	--

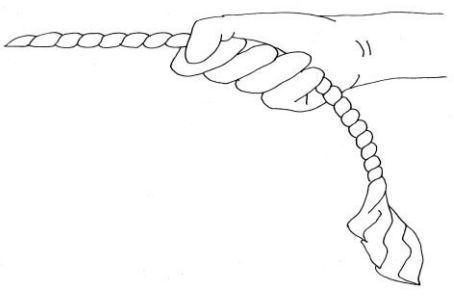

--	--	--	--

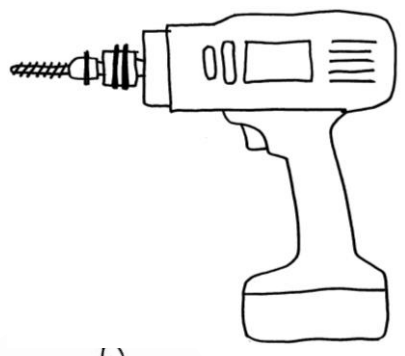

--	--	--	--



--	--	--	--

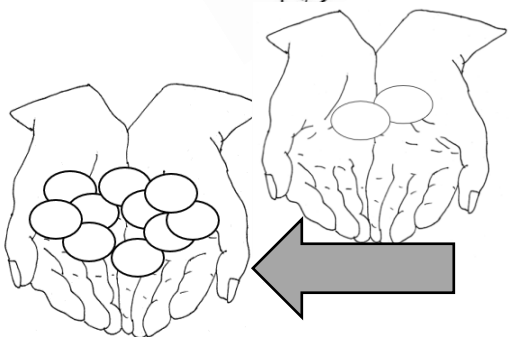

--	--	--	--

Long O, Magic E 2

Name: _____

Date: _____

Write the word: one letter in each box.

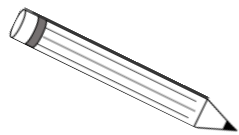

--	--	--	--	--

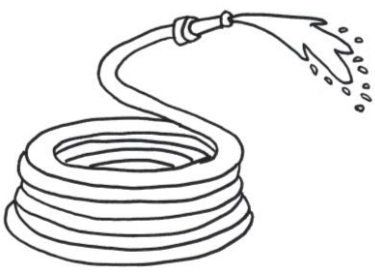

--	--	--	--

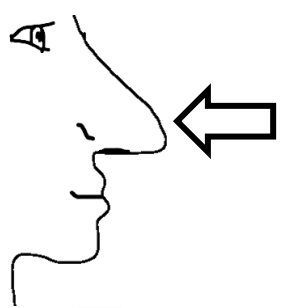

--	--	--	--

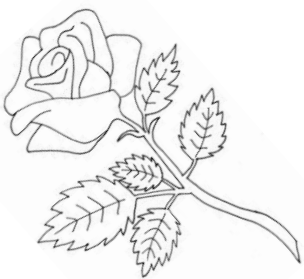

--	--	--	--

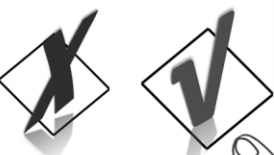

--	--	--	--	--

Long O, Magic E 2

Name: _____

Date: _____

Write the word: one letter in each box.

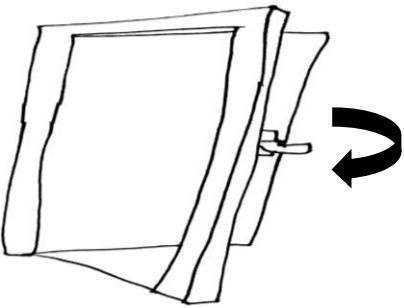
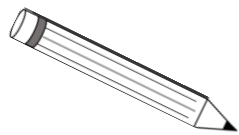

--	--	--	--	--

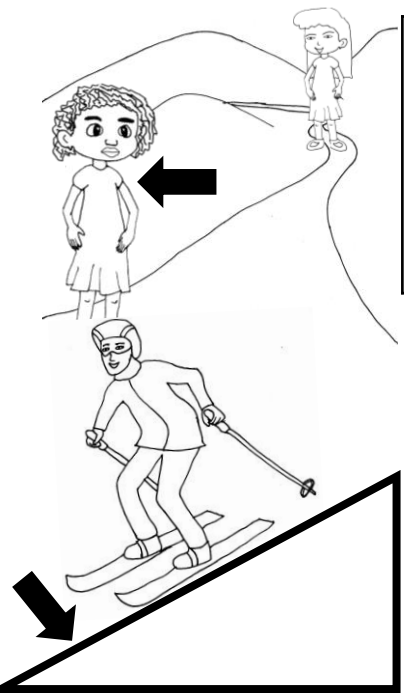

--	--	--	--	--

--	--	--	--	--



--	--	--	--

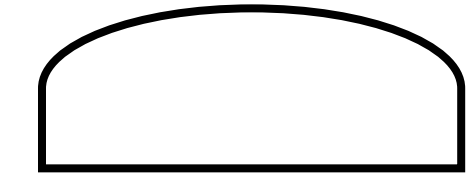

--	--	--	--

Long O, Magic E 2

Name: _____

Date: _____

Color a star for each time the page is read.



My Hike Up a Cliff

Sat:

I chose to go on a trip in the hills. We will hike to the top of a big, big rock. The guide will bore a hole in the side of the cliff. It is safe because the core of the dome is thick. We must scale the slope with ropes. I hope my rope is strong. When we camp we make a fire and put on robes. I hope I do not snore.

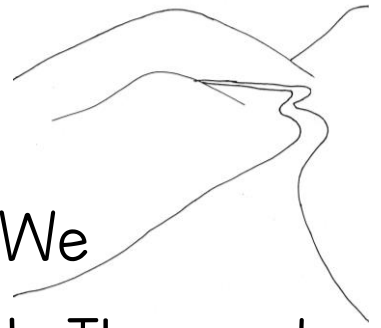

Sun:

When we rose in the morn, the guide did end the fire with a hose. I still smell the smoke with my nose. When we got close to the top, I was glad I chose this trip. It is so much more than what I did hope to find.

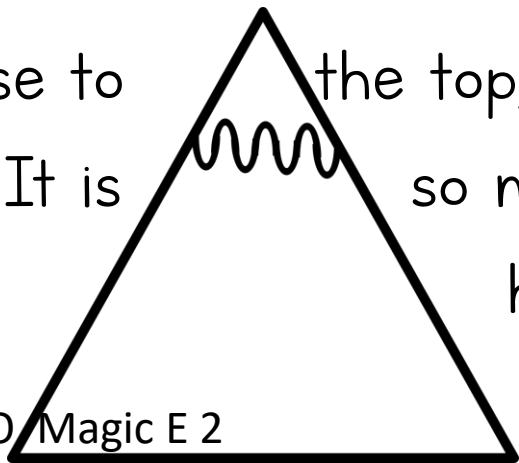

Long O Magic E 2