

Name: _____

Date: _____

Color Long Vowels red.

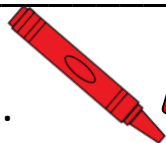

AEIOU

Color Silent E gray



E

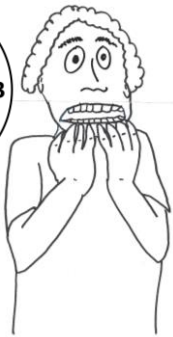
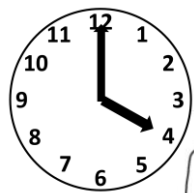

LATE

late

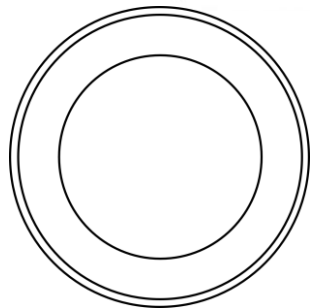

PLATE

plate

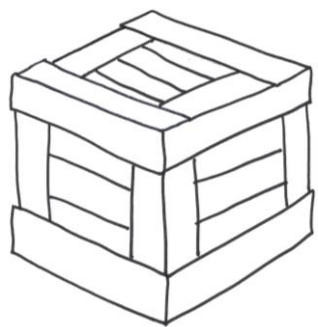

CRATE

crate



HATE

hate

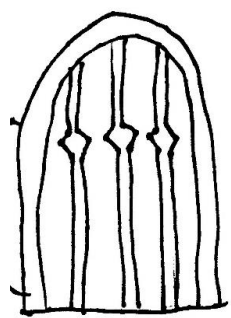

GATE

gate

Name: _____

Date: _____

Color Long Vowels red.

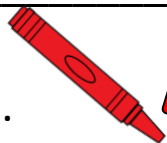

A E I O U

Color Silent E gray



E

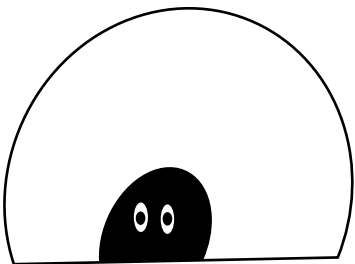

C A V E

c a v e

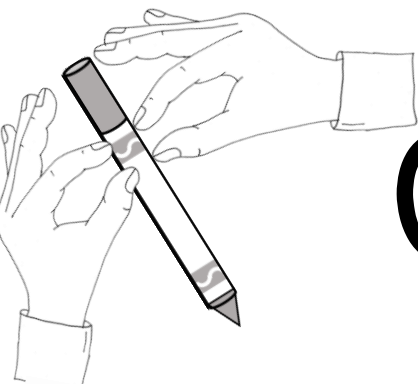

G A V E

g a v e

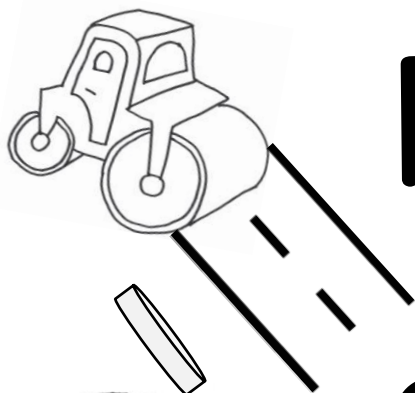

P A V E

p a v e

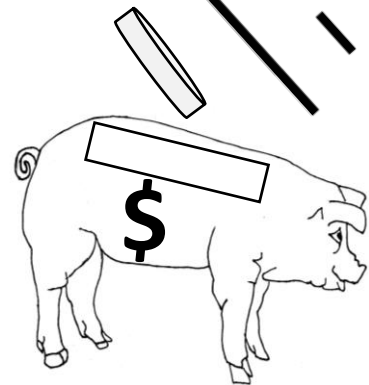

S A V E

s a v e



W A V E

w a v e

Name: _____

Date: _____

Trace the words.

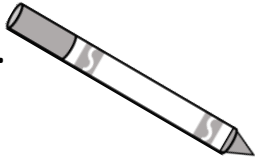

LATE

late

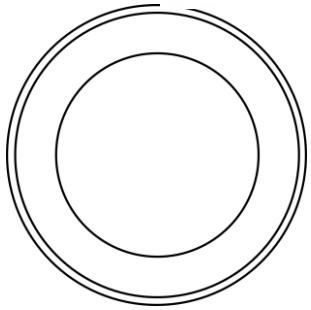

PLATE

plate

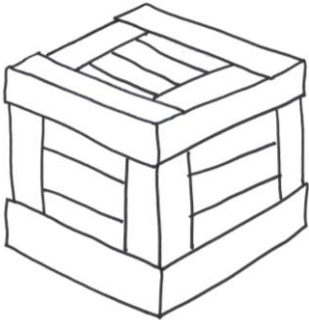

CRATE

crate



HATE

hate

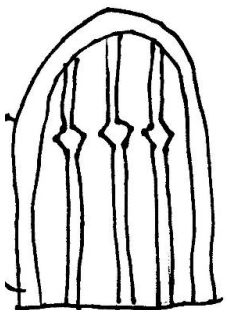

GATE

gate

Long A, Magic E 4

Name: _____

Date: _____

Trace the words.

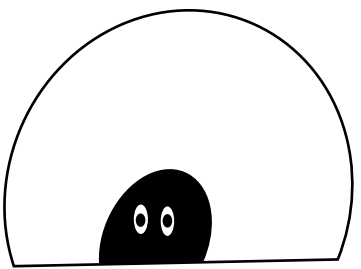
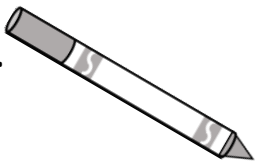

CAVE

cave

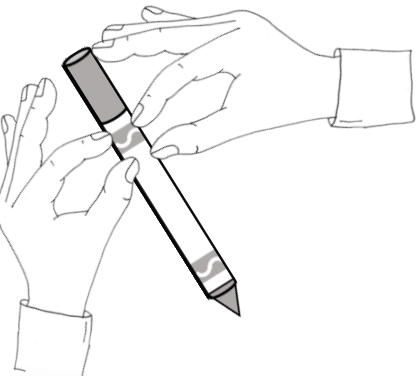

GAVE

gave

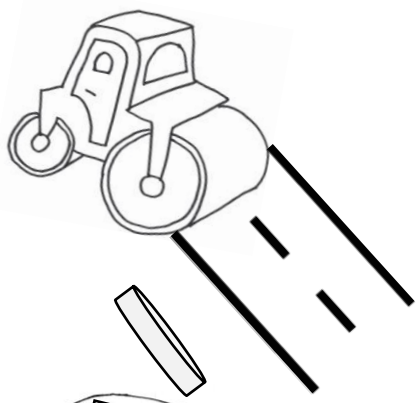

PAVE

pave

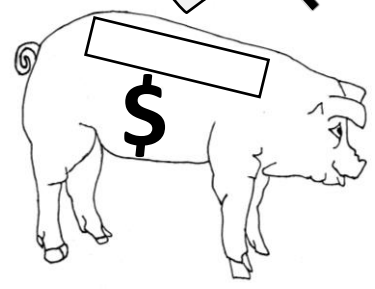

SAVE

save

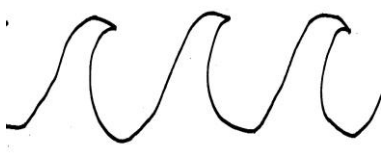

WAVE

wave

Name: _____

Date: _____

Write the word: one letter in each box.

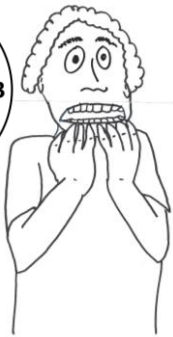
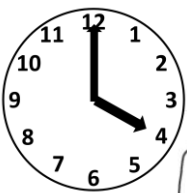
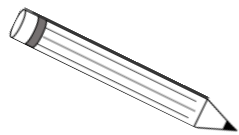

--	--	--	--

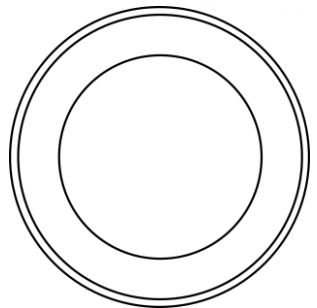

--	--	--	--	--

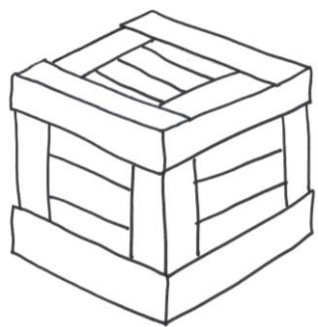

--	--	--	--	--



--	--	--	--

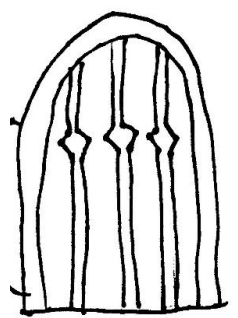

--	--	--	--

Long A, Magic E 4

Name: _____

Date: _____

Write the word: one letter in each box.

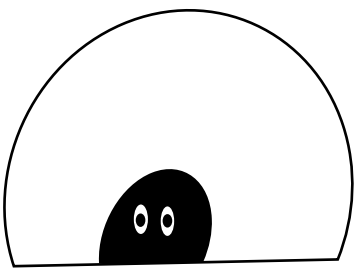
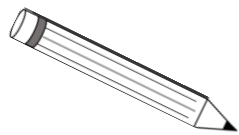

--	--	--	--

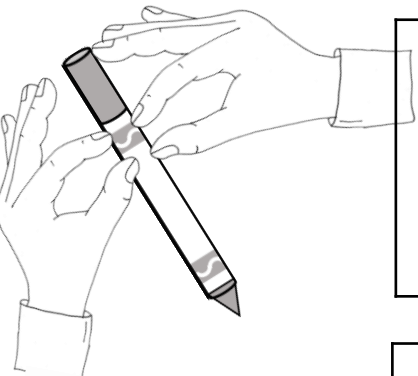

--	--	--	--

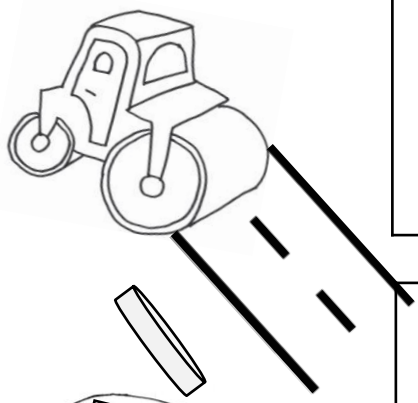

--	--	--	--

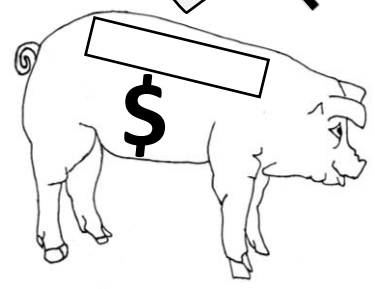

--	--	--	--



--	--	--	--

Long A, Magic E 4

Name: _____

Date: _____

Color a star for each time the page is read.



I Am So Late!

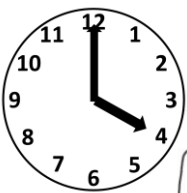

I am so late! I have a big date. I must be quick and get there.

I hate to make my host stand at the gate and gaze for me. My host will have gold plates from a crate. My host

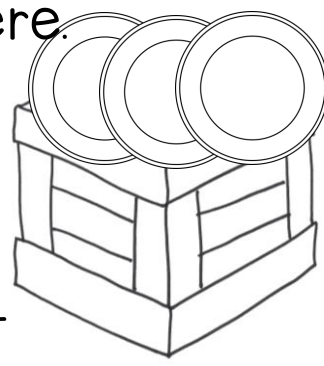

will save me a spot but I will miss the film of his trip to a cave. He had to cross a lot of waves to save a kid that did not swim. He had to go on rocks. There was no pavement. The kid's mom and dad gave my host a gift because he was so brave.. When I get there, I will ask my host to share his tale of the big cave save.

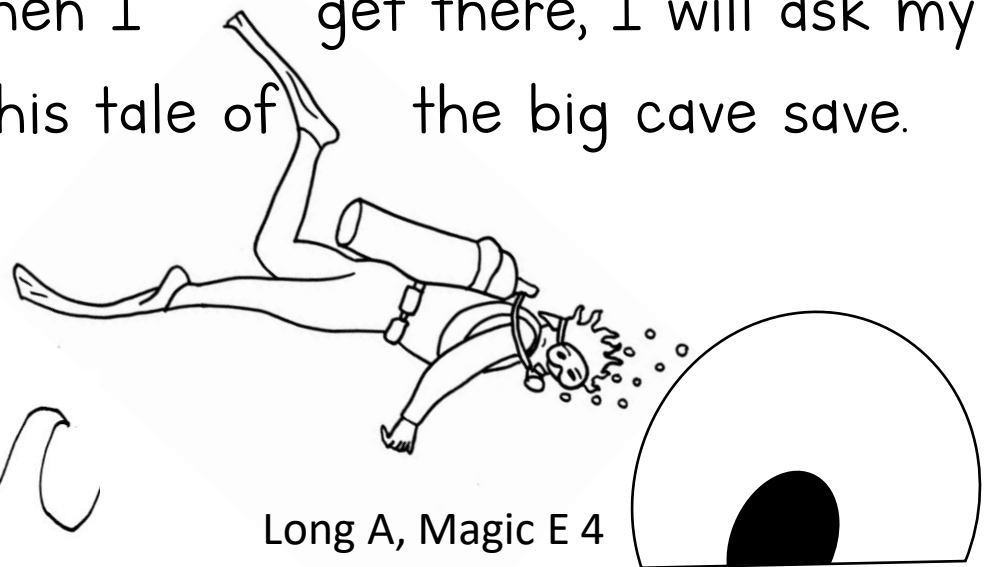

Long A, Magic E 4